

Stoły, stoliki, wieszaki



profim

Stoły, stoliki, wieszaki



Chic Stoliki 4-7



Hover Stoliki 8-9



MyTurn Sofa Stoliki 10-11



October Stoliki 12-13



SAM Stoliki 14-15



Sensi Stoły 16-17



SF/SH/SR/SV/SW Stoliki 18-21



SFT Stoły 22-23



Vancouver Stoliki 24-25



Seven 26-27

Chic Stoliki

Design: Christophe Pillet



Minimalistyczne stoliki w wersji restauracyjnej. Różne kształty, kilka rozmiarów i wiele wykończeń.

Metalowy stelaż w siedmiu wariantach kolorystycznych.

Blat do wyboru ze szkła hartowanego, z blachy, w okleinie naturalnej lub z ceramiki.





CHIC RR40 EPO3



CHIC RR30 EPO2 CER2



CHIC RR20 SATYNA G1



CHIC RR10 EPO1 G1



CHIC RH20 EPO2 CER2



CHIC RH30 SATYNA G1



CHIC RH30 EPO3 CER3



Chic Stoliki

Design: Christophe Pillet



CHIC CR41 EPO3 G2



CHIC CR40 EPO3 G2



CHIC CS41 EPO2 CER2



CHIC CS40 EPO2 CER2



CHIC CS30 EPO2 CER2



Hover Stoliki

Design: Tomek Rygalik, Studio Rygalik



Stoliki kawowe
w trzech rozmiarach.

Stelaż w atrakcyjnych
wybarwieniach RAL.

Blat ze szkła hartowanego bądź
wytrzymałego materiału HPL.



HOVER S3 RAL 1023 LW



HOVER S2 RAL 1023 G1



HOVER S1 RAL 1023 G1

MyTurn Sofa Stoliki

Design: Paul Brooks



Stoliki w dwóch rozmiarach.

Dwa rodzaje stelaża:
płóza i nogi.

Błat w okleinie naturalnej bądź
z wytrzymałego materiału HPL.





MYTURN SOFA STOLIK S2H SATYNA LW



MYTURN SOFA STOLIK S1H CHROM LW



MYTURN SOFA STOLIK S2V CHROM HM



MYTURN SOFA STOLIK S1V CHROM HM



October Stoliki

Design: Hilary Birkbeck



Stoliki w dwóch rozmiarach,
z możliwością zastosowania
wstawki ze szkła mlecznego.

Dwa rodzaje nóg:
drewniana i metalowa.





OCTOBER S2 WOOD



OCTOBER S1 WOOD G1



OCTOBER S2 CHROM G1



OCTOBER S1 CHROM G1



SAM Stoliki

Design: ITO Design



Stoliki na drewnianych nogach
bukowych lub dębowych
w trzech rozmiarach.

Blat ze szkła hartowanego
bądź wytrzymałego na
zarysowania materiału HPL.





SAM3 G1



SAM2 LW04



SAMC1 LW02



SAMC2 G2

Sensi Stoły



Stoły konferencyjne w czterech rozmiarach z możliwością sztaplowania (4 sztuki).

Blat ze szkła hartowanego, w okleinie naturalnej bądź z wytrzymałego materiału HPL.





SENSI S3 CHROM HM10



SENSI S2 CHROM HM20



SENSI S4 CHROM G1



SENSI S1 CHROM HM20

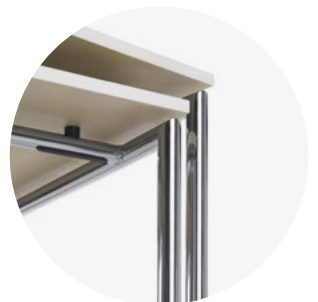

SF/SH/SR/SV/SW Stoliki



Stoliki kawowe o różnych wysokościach.

Pięć rodzajów baz do wyboru. Błat ze szkła mlecznego hartowanego.





SF30 CHROM



SF20 CHROM



SV40 SATYNA



SW40

SF/SH/SR/SV/SW Stoliki



SH30 CHROM



SH20 CHROM



SH10 CHROM



SR40 CHROM



SR30 CHROM



SR20 CHROM



SR10 CHROM



SFT Stoły

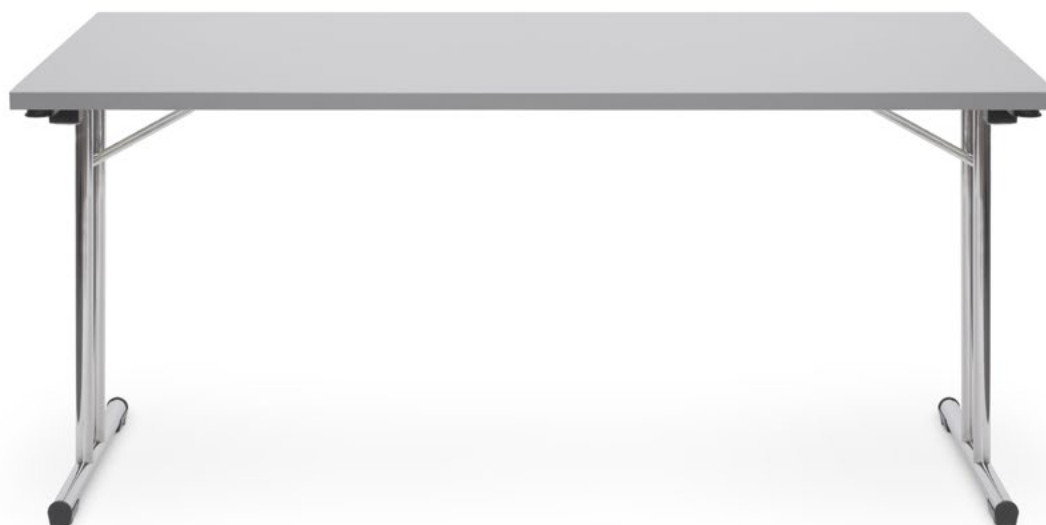

SFT1 CHROM LW

Składane stoły do sal konferencyjnych i wykładowych.

Funkcja łączenia stołów pozwala na tworzenie łatwo rearanżowanych układów.

Sztaplowanie do 10 sztuk.





Vancouver Stoliki



Stoliki kawowe w dwóch rozmiarach.

Dwa rodzaje stelaża: o profilu okrągłym i kwadratowym.

Blat ze szkła hartowanego, w okleinie naturalnej bądź z wytrzymałego materiału HPL.





VANCOUVER STOLIK S3 SATYNA LW



VANCOUVER STOLIK S2 SATYNA LW



VANCOUVER STOLIK SH3 SATYNA HM20

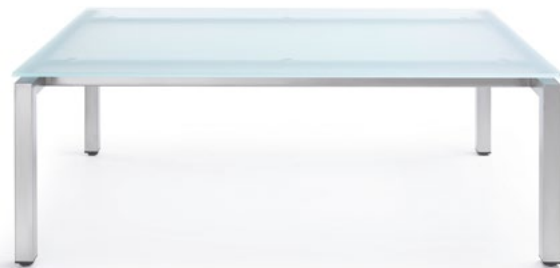

VANCOUVER STOLIK SH2 SATYNA G1



Seven

Design: Tomek Rygalik, Studio Rygalik



Możliwość połączenia
różnych kolorów stelaża
i haczyków na ubrania.



SEVEN RAL 1023 / CZARNY

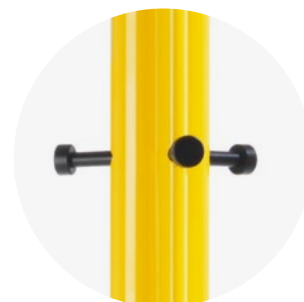

Skonfiguruj swój produkt

Przy zamówieniu prosimy stosować symbole według kodu.









Chic Stoliki ¹

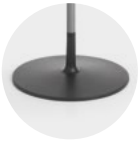





Stelaż / baza

Wysokość

Kolor stelaża ²

Blat



 <p>Okrągła</p> <p>RR</p>	 <p>h=480 mm</p> <p>40</p>	 <p>h=660 mm</p> <p>30</p>
	 <p>h=740 mm</p> <p>20</p>	 <p>h=1100 mm</p> <p>10</p>
 <p>Na nogach</p> <p>RH</p>	 <p>h=660 mm</p> <p>30</p>	 <p>h=740 mm</p> <p>20</p>

 <p>CZARNY</p>	 <p>METALIK</p>
 <p>EPO1 Biały</p>	 <p>EPO2 Szary</p>
 <p>EPO3 Grafitowy</p>	 <p>CHROM</p>
 <p>SATYNA</p>	



Szkło

 <p>G1 Mleczny</p>	 <p>G2 Czarny</p>	 <p>G3 Szaro-beżowy (RAL 7044)</p>
 <p>G4 Szary (RAL 7042)</p>		





Ceramika

 <p>CER1 Biały</p>	 <p>CER2 Szary</p>	 <p>CER3 Grafitowy</p>
--	--	--

Blacha

 <p>EPO1 Biały</p>	 <p>EPO2 Szary</p>	 <p>EPO3 Grafitowy</p>
---	---	---

Okleina naturalna modyfikowana

 <p>HM10 Dąb bielony</p>	 <p>HM11 Dąb classic</p>	 <p>HM12 Dąb cardinal</p>
 <p>HM30 Teak</p>	 <p>HM20 Wenge classic</p>	

Dodatkowe

Stopki

TWARDE
Do powierzchni miękkich.

FILCOWE
Do powierzchni twardych.

TEFLON
Uniwersalne.

¹ Stoliki RR / RH z blatem z blachy i ceramiki (dotyczy kolumny EPO1, EPO2, EPO3, stopki twarde lub teflonowe) mogą być użytkowane na zewnątrz zgodnie z normą EN 12944-2 kat. C3.

² W modelu RR kolor stelaża dotyczy kolumny. Baza żeliwna zawsze czarna.

Chic Stoliki

Stolik



Kwadratowy

CS

Rozmiar



1200 x 1200
x 250 mm

41



800 x 800
x 250 mm

40



450 x 450
x 560 mm

30



Okrągły

CR



Ø 1200 mm,
h=250 mm

41



Ø 800mm,
h=250 mm

40

Kolor stelaża



CZARNY



METALIK



EPO1

Biały



EPO2

Szary



EPO3

Grafitowy



CHROM



SATYNA

Blat

Szkło



G1

Mleczny



G2

Czarny



G3

Szaro-beżowy
(RAL 7044)



G4

Szary (RAL 7042)

Ceramika



CER1

Biały



CER2

Szary



CER3

Grafitowy

Blacha¹



EPO1

Biały



EPO2

Szary



EPO3

Grafitowy

Okleina naturalna modyfikowana



HM10

Dąb bielony



HM11

Dąb classic



HM12

Dąb cardinal



HM30

Teak



HM20

Wenge classic

Dodatkowe

Stopki

TWARDE

Do powierzchni miękkich.

FILCOWE

Do powierzchni twardych.

TEFLON

Uniwersalne.

¹ Dotyczy wersji CS30.

Skonfiguruj swój produkt

Przy zamówieniu prosimy stosować symbole według kodu.

Hover Stoliki

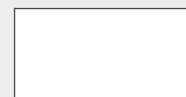

Rodzaj stolika



Mały

(450 x 440 x 450 mm)

S3



Średni

(890 x 370 x 550 mm)

S2



Duży

(1200 x 370 x 740 mm)

S1

Kolor stelaża



CZARNY



CHROM



METALIK



SATYNA



RAL 9016

Biały



RAL 1023

Żółty



RAL 3020

Czerwony



RAL 5018

Turkusowy

Blat

Sztko



G1

Mleczny

Laminat HPL



LW01

Biały



LW04

Szary



LW02

Czarny

MyTurn Sofa Stoliki

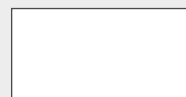

Rodzaj stolika

Stelaż

Kolor stelaża

Blat



Maty

(850 x 300 x 850 mm)

S2



Duży

(1200 x 300 x 850 mm)

S1



Na nogach

H

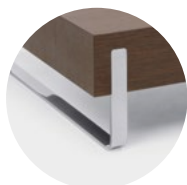

Na płozach

V



CZARNY



CHROM



METALIK



SATYNA

Laminat HPL



LW01

Biały



LW02

Czarny



LW04

Szary

Okleina naturalna modyfikowana



HM10

Dąb bielony

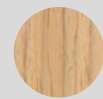

HM11

Dąb classic

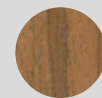

HM12

Dąb cardinal

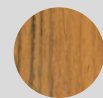

HM30

Teak



HM20

Wenge classic

Dodatkowe

Stopki ¹

TWARDE

Do powierzchni miękkich.

FILCOWE

Do powierzchni twardych.

¹ Dotyczy wersji H.

Skonfiguruj swój produkt

Przy zamówieniu prosimy stosować symbole według kodu.

October Stoliki



Rodzaj stolika

Kolor nóg

Blat

Kolor blatu ²



Mały

(600 x 350 x 600 mm)

S2



Duży

(600 x 350 x 1200 mm)

S1



CZARNY



METALIK



CHROM



SATYNA

Lakier (buk)



H8



H6



H7



H12



H11



H5



DREWNO ZE SZKŁEM ¹



DREWNO

Lakier (buk)



H8



H6



H7



H12



H11



H5

Dodatkowe

Stopki

TWARDE

Do powierzchni miękkich.

FILCOWE

Do powierzchni twardych.

¹ Szkło zawsze mleczne (G1).

² Możliwość wyboru koloru blatu tylko w wersji z nogami metalowymi. W przypadku nóg drewnianych blat występuje w tym samym kolorze.

SAM Stoliki

Rodzaj stolika

Kolor stelaża

Blat



Stół kawowy mały

(1400 x 700 x 650 mm)

SAM3



Stół kawowy mały

(1400 x 900 x 650 mm)

SAM2



Stół konferencyjny

(2000 x 900 x 740 mm)

SAMC1



Stół konferencyjny

(1400 x 900 x 740 mm)

SAMC2

Lakier (buk)



H13



H8



H6



H7



H12



H11



H5

Lakier (dąb)



HO6



HO12



HO11

Szkło



G1

Mleczny



G2

Czarny



G3

Szaro-beżowy
(RAL 7044)



G4

Szary
(RAL 7042)

Laminat HPL



LW01

Biały



LW02

Czarny



LW04

Szary

Dodatkowe

Stopki

TWARDE

Do powierzchni miękkich.

FILCOWE

Do powierzchni twardych.

TEFLON

Uniwersalne.

Skonfiguruj swój produkt

Przy zamówieniu prosimy stosować symbole według kodu.

Sensi Stoły



Rodzaj stołu



Mały

(800 x 740 x 800 mm)

S3



Średni

(1200 x 740 x 800 mm)

S2



Średni

(1400 x 740 x 800 mm)

S4



Duży

(1600 x 740 x 800 mm)

S1

Kolor stelaża



CZARNY



METALIK



CHROM



SATYNA

Blat

Sztko



G1

Mleczny

Laminat HPL



LW01

Biały



LW02

Czarny



LW04

Szary

Okleina naturalna modyfikowana



HM10

Dąb bielony



HM11

Dąb classic



HM12

Dąb cardinal



HM30

Teak



HM20

Wenge classic

Dodatkowe

Stopki

TWARDE

Do powierzchni miękkich.

FILCOWE

Do powierzchni twardych.

SF/SH/SR/SV/SW Stoliki

Baza / stelaż



Baza 4-ramienna

SF



Stelaż na nogach

SH



Baza okrągła

SR



Stelaż z metalowego pręta

SV



Stelaż na nogach drewnianych

SW

Opcja – wykończenie blatu w laminatach HPL¹

Dotyczy wersji SH, SR.



LW01

Biały



LW02

Czarny



LW04

Szary

Rodzaj stolika



h=450 mm

Dotyczy wersji SH, SR, SV, SW.

40



h=600 mm

Dotyczy wersji SF, SH, SR.

30



h=720 mm

Dotyczy wersji SF, SH, SR.

20



h=1100 mm

Dotyczy wersji SR.

10

Kolor stelaża



CZARNY

Dotyczy wersji SH, SR, SV.



METALIK

Dotyczy wersji SH, SR, SV.



CHROM

Dotyczy wersji SF, SH, SR, SV.



SATYNA

Dotyczy wersji SH, SV.

Wybarwienia nóg drewnianych

Dotyczy wersji SW.

Lakier (buk)



H13



H8



H6



H7



H12



H11



H5

Lakier (dąb)



HO6



HO12



HO11

Dodatkowe

Stopki

TWARDE

Do powierzchni miękkich.

FILCOWE

Do powierzchni twardych.

¹ W standardzie szkło mleczne (G1).

Skonfiguruj swój produkt

Przy zamówieniu prosimy stosować symbole według kodu.

SFT Stoły



Rodzaj stołu



Składany

(1600 x 800 x 740 mm)

SFT1

Kolor stelaża



CZARNY



METALIK



CHROM



SATYNA

Blat ¹

Laminat HPL



LW01

Biały



LW02

Czarny



LW04

Szary

Dodatkowe

Stopki

TWARDE

Do powierzchni miękkich.

FILCOWE

Do powierzchni twardych.

Akcesoria



Wózek do transportu stołów

SFT W



Łączniki

Możliwość łączenia stołów – komplet łączników (4 szt. zamontowane do blatu).
Możliwość zamówienia łącznika jako osobnego elementu (np. do łączenia stołów w kształt litery L lub U).

¹ Standard – blat wykonany z płyty wiórowej.
Opcja – blat wykonany z płyty komórkowej.

Vancouver Stoliki

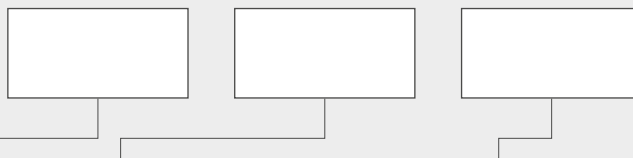

Rodzaj stolika

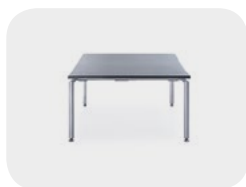

Mały

stelaż z rury o profilu okrągłym
(800 x 460 x 800 mm)

S3



Mały

stelaż z rury o profilu kwadratowym
(800 x 460 x 800 mm)

SH3



Średni

stelaż z rury o profilu okrągłym
(1200 x 460 x 800 mm)

S2



Średni

stelaż z rury o profilu kwadratowym
(1200 x 460 x 800 mm)

SH2

Kolor stelaża



CZARNY



METALIK



CHROM



SATYNA

Blat

Sztko



G1

Mleczny

Laminat HPL



LW01

Biały



LW02

Czarny



LW04

Szary

Okleina naturalna modyfikowana



HM10

Dąb bielony



HM11

Dąb classic



HM12

Dąb cardinal



HM30

Teak



HM20

Wenge classic

Dodatkowe

Stopki

TWARDE

Do powierzchni miękkich.

FILCOWE

Do powierzchni twardych.

Skonfiguruj swój produkt

Przy zamówieniu prosimy stosować symbole według kodu.

Seven



Kolor stelaża

Kolor haczyka

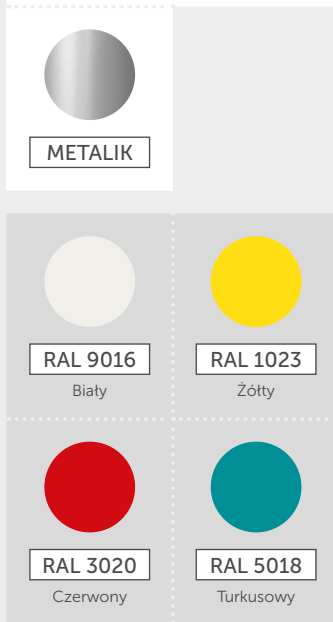
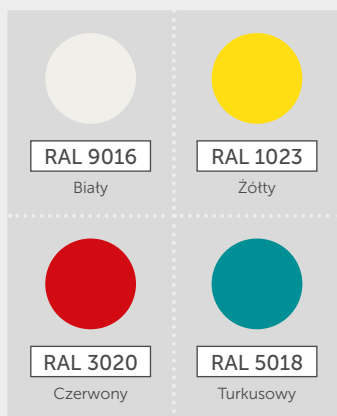
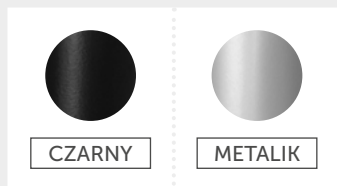

Wymiary

Chic Stoliki

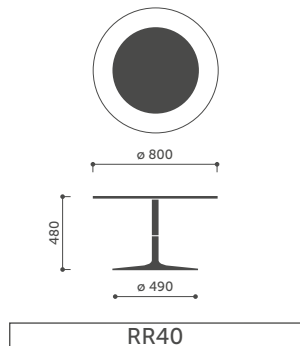

RR40

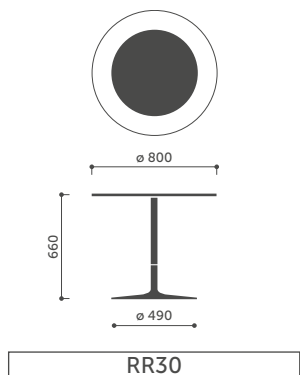

RR30

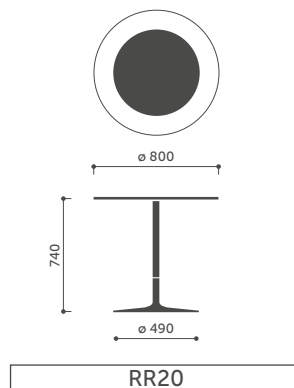

RR20

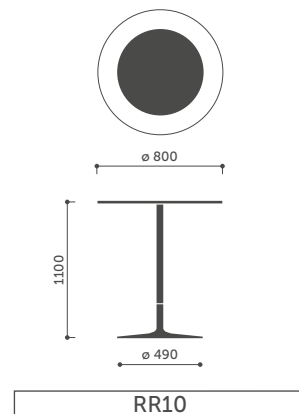

RR10

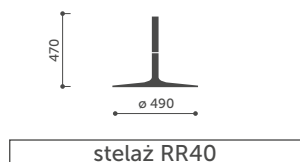

stelaż RR40

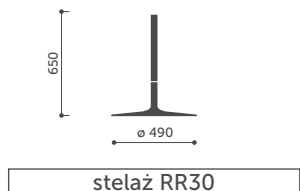

stelaż RR30

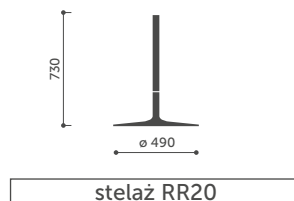

stelaż RR20

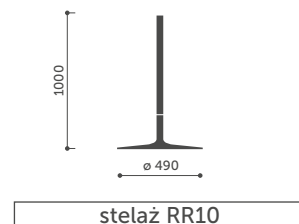

stelaż RR10

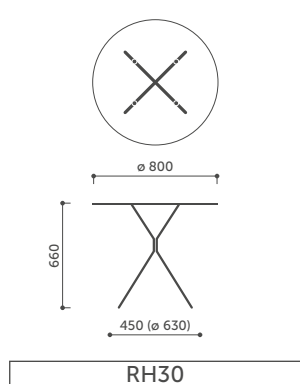

RH30

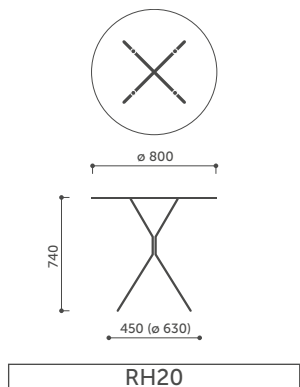

RH20

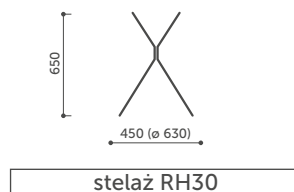

stelaż RH30

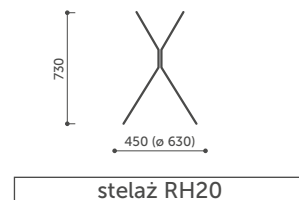

stelaż RH20

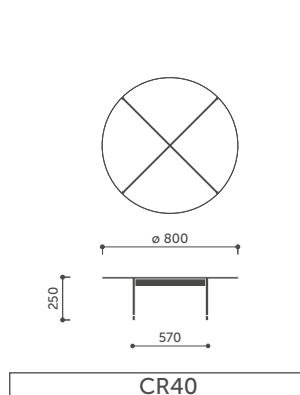

CR40

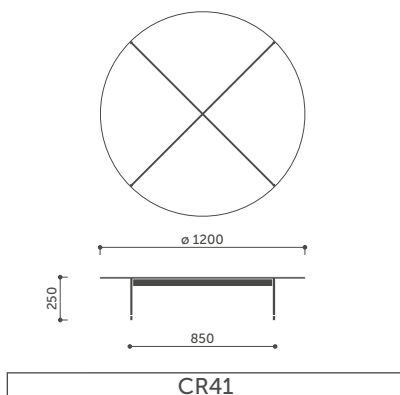

CR41

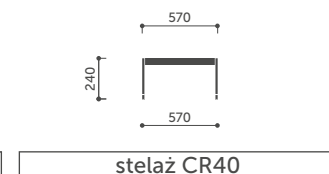

stelaż CR40

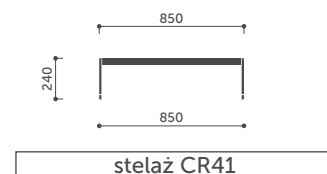

stelaż CR41

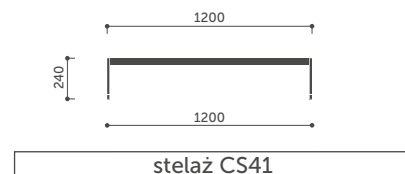
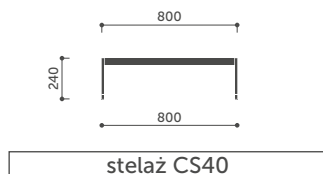
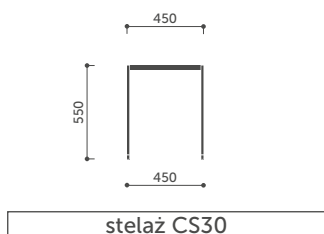
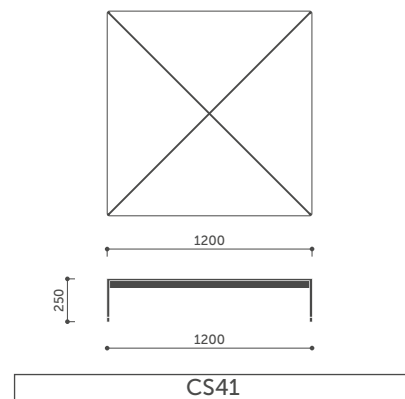
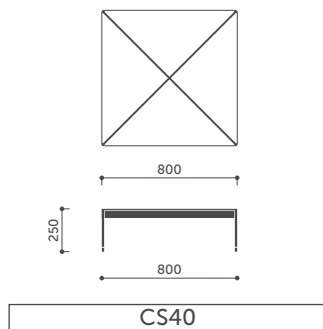
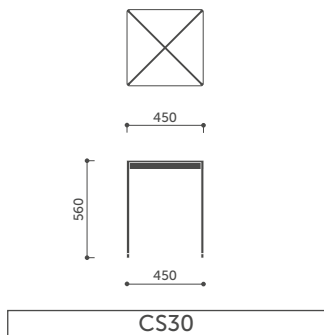

Hover Stoliki

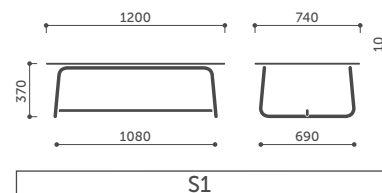
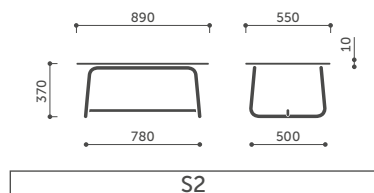
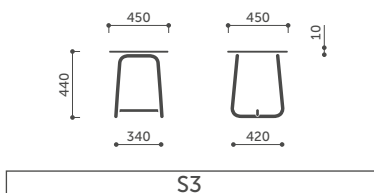

MyTurn Sofa Stoliki

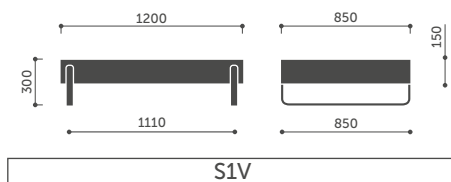
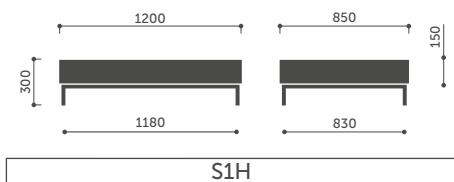
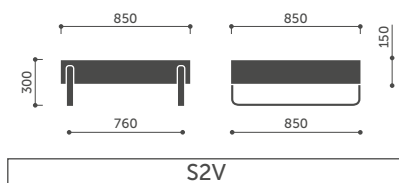
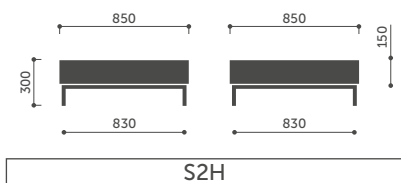

October Stoliki

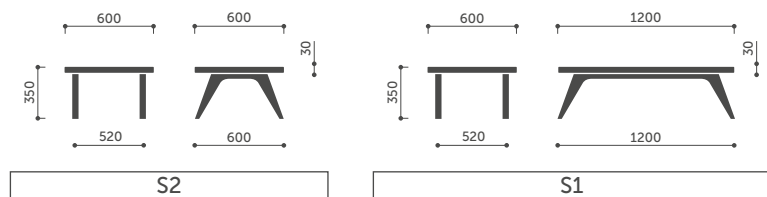

SAM Stoliki

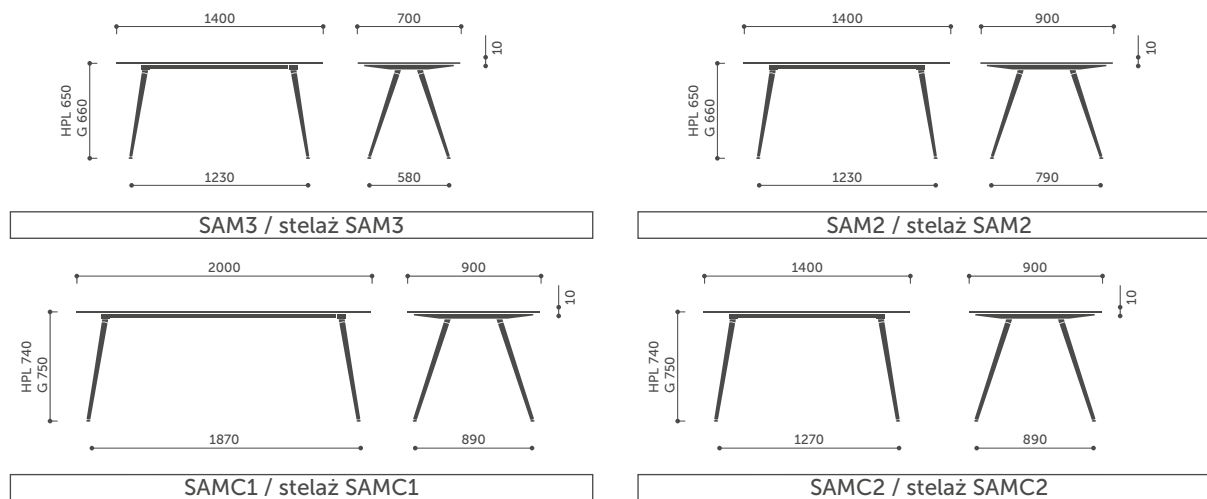

Sensi Stoły

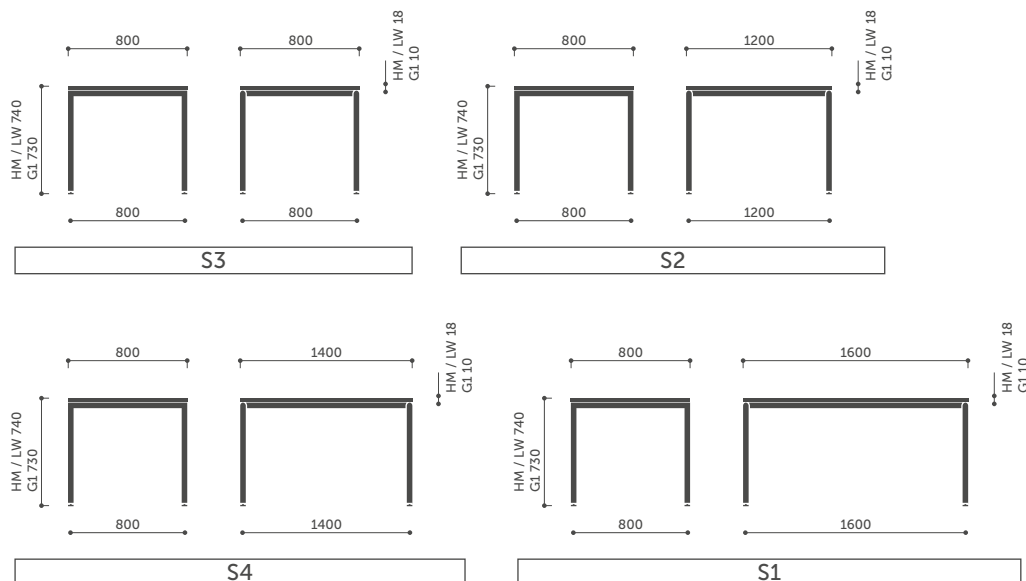

SF/SH/SR/SV/SW Stoliki

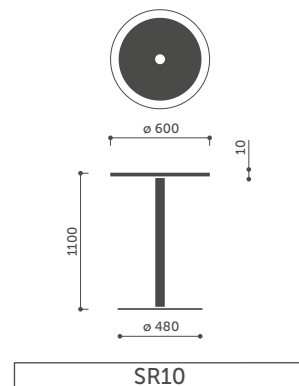
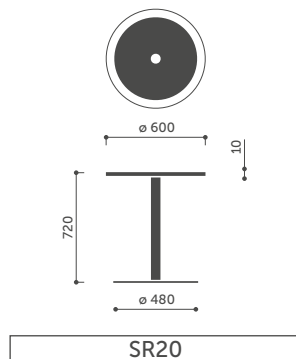
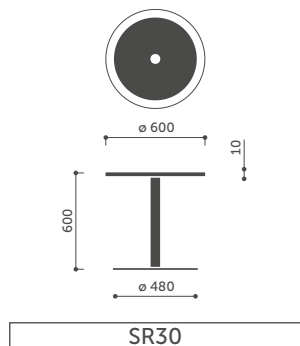
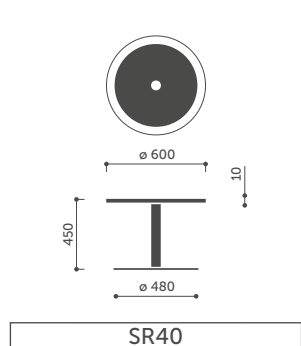
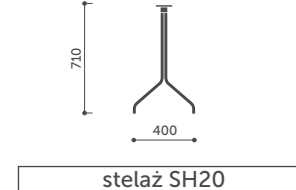
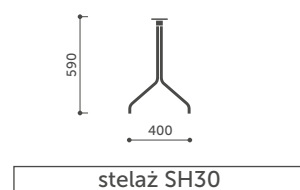
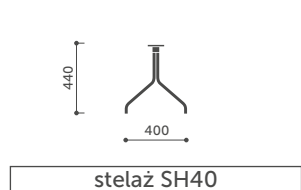
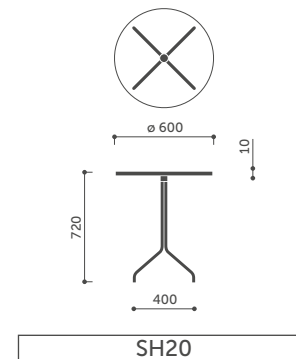
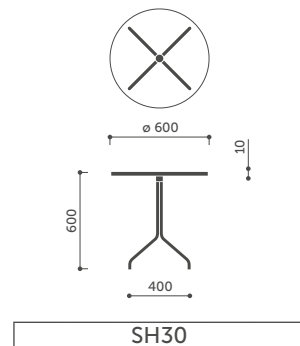
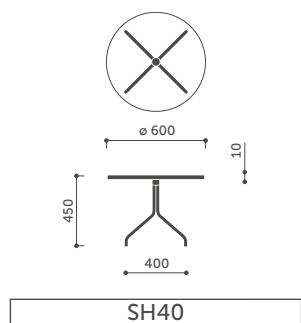
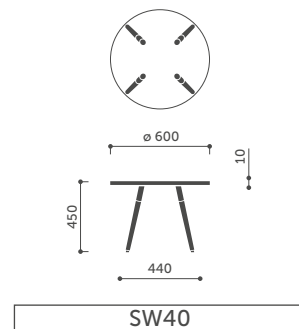
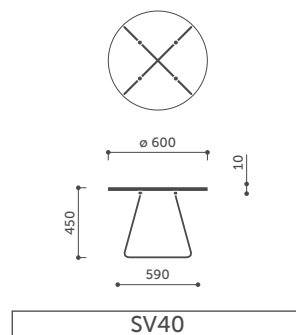
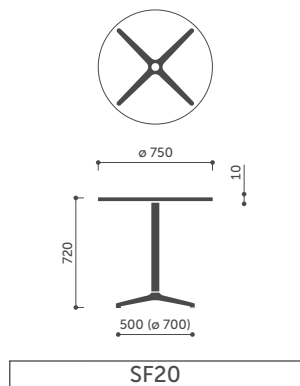
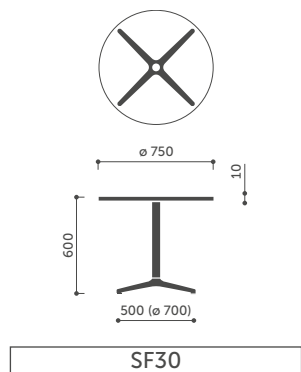

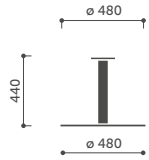

stelaż SR40

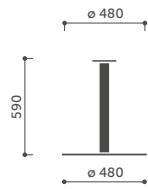

stelaż SR30

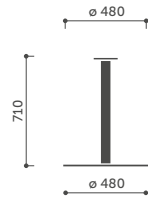

stelaż SR20

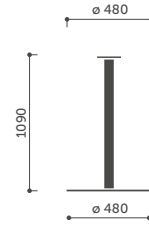

stelaż SR10

SFT Stoty

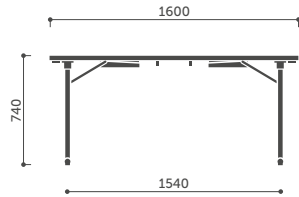

SFT1

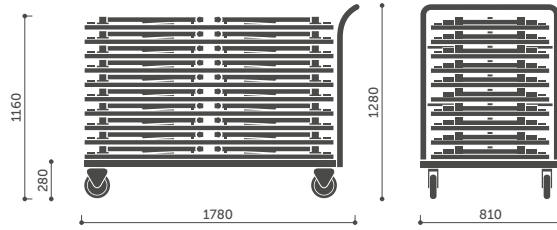
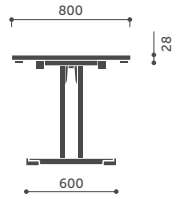

SFT W

Vancouver Stoliki

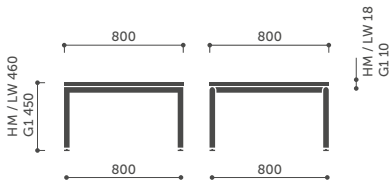

S3

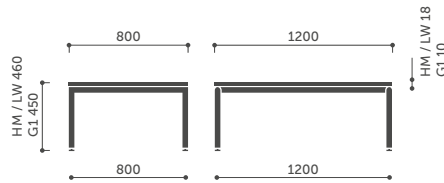

S2

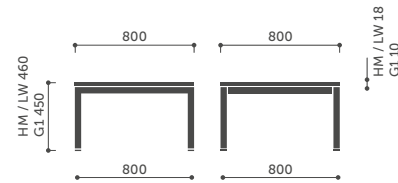

SH3

Seven

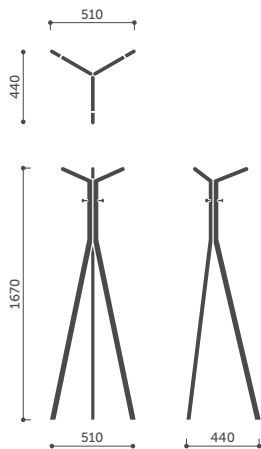

SEVEN

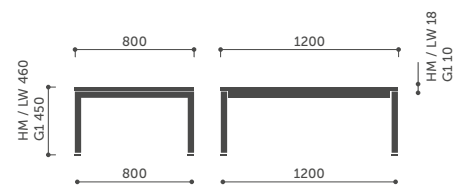

SH2

Wzornik wykończeń

Stelaż / blat

Chic Stoliki

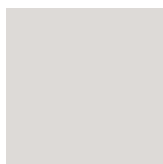

EPO1



EPO2

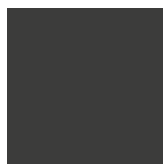

EPO3

RAL

Hover Stoliki, Seven

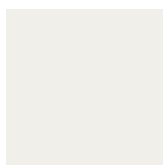

RAL 9016



RAL 1023



RAL 3020



RAL 5018

HPL

Hover Stoliki,
MyTurn Sofa Stoliki,
SAM Stoliki, Sensi Stoły,
SH/SR Stoliki, SFT Stoły,
Vancouver Stoliki



LW01

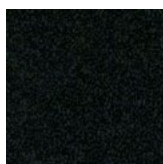

LW02



LW04

Ceramika

Chic Stoliki

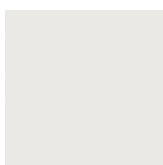

CER1

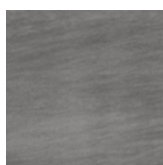

CER2



CER3

Szkło hartowane

Chic Stoliki, SAM Stoliki



G1 (MLECZNY)

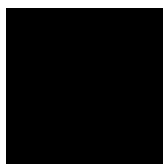

G2 (CZARNY)



G3 (RAL 7044)



G4 (RAL 7042)

Szkło hartowane

Hover Stoliki, October
Stoliki, Sensi Stoły,
SF/SH/SR/SV/SW Stoliki,
Vancouver Stoliki



G1 (MLECZNY)

Drewno

October Stoliki, SAM
Stoliki, SW Stoliki

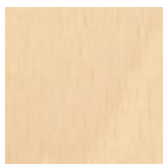

H8

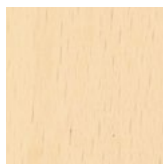

H6

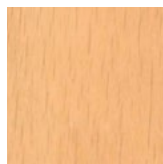

H7

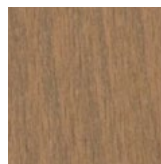

H12

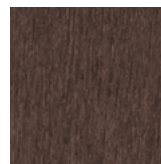

H11

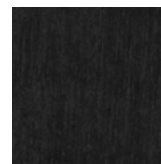

H5

Drewno

SAM Stoliki, SW Stoliki

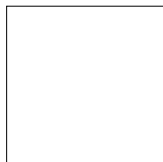

H13

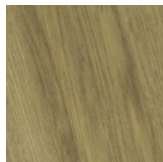

HO6

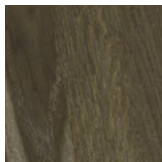

HO12

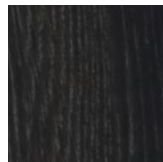

HO11

Okleiny naturalne

Chic Stoliki, MyTurn
Sofa Stoliki, Sensi Stoły,
Vancouver Stoliki



HM10

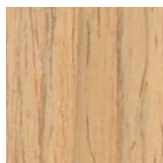

HM11

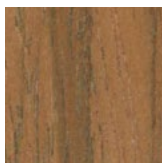

HM12

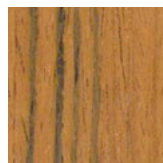

HM30

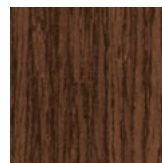

HM20



stopki filcowe



stopki teflonowe



sztaplowanie (ilość)



sztaplowanie na wózku (ilość)



łączenie w rzędy

www.profim.pl

Producent zastrzega sobie prawo do zmian konstrukcyjnych i zmiany parametrów nie pogarszających walorów użytkowych produktów. Kolory reprodukowane w katalogu mogą odbiegać od rzeczywistych kolorów oferowanych mebli.



CHROM (III)
Technologia przyjazna
dla środowiska

CHROMIUM (III)
Eco-Friendly Technology

